

# Series 710, 715

## Atmospheric Vacuum Breakers

Size: 1/2" - 2" (15mm - 50mm)

The FEBCO Series 710, 715 Atmospheric Vacuum Breakers are designed for use in multiple water applications such as:

- Hose bibbs
- Chemical vats
- X-ray tanks
- Turf irrigation systems
- Laboratory sinks

### Features

- Meets all specifications of ASSE
- Documented flow curves established by The Twining Labs, Inc.
- Simple service procedures.
- Light weight plastic poppets.
- Resilient rubber poppet discs designed for positive closure.
- Cold water applications.
- End Detail – NPT thread ANSI B2.1

### Operation

FEBCO Series 710, 715 assures positive protection against backsiphonage of impure water into the main supply in the event that pressure loss causes vacuum conditions. A poppet seals the air inlet when the unit is pressurized. When a backsiphonage occurs, the poppet drops to allow air to enter the downstream piping. At the same time the poppet shields the water inlet to prevent foreign materials from entering the upstream piping. Restoration of pressure (flow) lifts the poppet to seal the air inlet.

### Specifications

Atmospheric Vacuum Breakers shall be installed on the discharge side of the last shutoff valve, shall have all bronze bodies and bonnets, and shall be of the non-spilling type. Vacuum breaker shall be rated to 150psi (10.3 bar) working pressure and shall withstand water temperatures of 32°F to 110°F (0°C - 43°C) for the Series 710 (1" - 2") (25 - 50mm) and 32°F to 180°F (0°C - 82°C) for the 715 (1/2" - 3/4") (15-20mm).

### Approvals – Standards



715 1/2" - 3/4" (15-20mm)  
710 1" - 2" (25-50mm)

### Typical Installation

An Atmospheric Vacuum Breaker may be used to protect a cross-connection against backsiphonage, where the vacuum breaker is not subjected to back pressures due to pumps or any other conditions which may cause backpressure, no matter how slight. It must be installed on the discharge side of the last shutoff valve. Code requirements vary as to the height this vacuum breaker must be installed above the highest overflow level but a minimum of 6" (150mm) is required. The atmospheric vacuum breaker must be installed with the air inlet in a level position.

**NOTE:** No valve of any type may be installed on the discharge side of an atmospheric vacuum breaker.

### Model 710/715

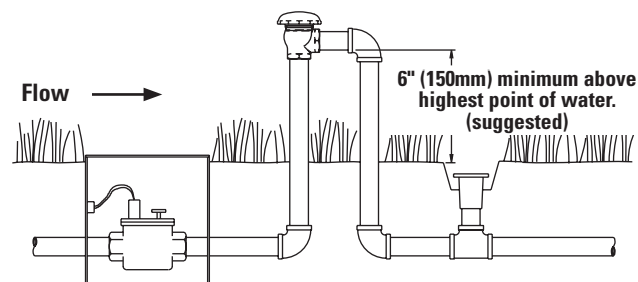

**NOTE:** Unit cannot have any shutoff downstream of it.

Job Name \_\_\_\_\_

Job Location \_\_\_\_\_

Engineer \_\_\_\_\_

Approval \_\_\_\_\_

Contractor \_\_\_\_\_

Approval \_\_\_\_\_

Contractor's P.O. No. \_\_\_\_\_

Representative \_\_\_\_\_

FEBCO product specifications in U.S. customary units and metric are approximate and are provided for reference only. For precise measurements, please contact FEBCO. FEBCO reserves the right to change or modify product design, construction, specifications, or materials without prior notice and without incurring any obligation to make such changes and modifications on FEBCO products previously or subsequently sold.

# Capacity

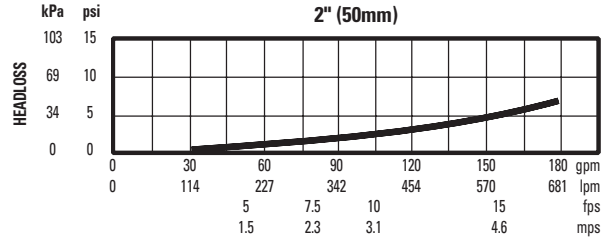
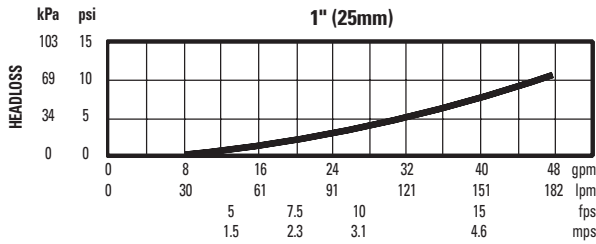
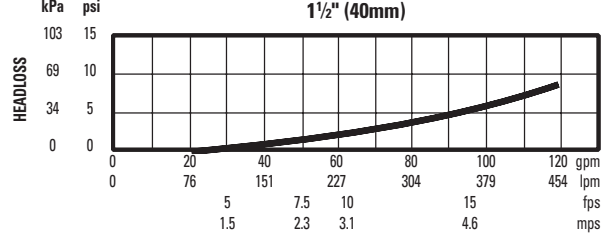
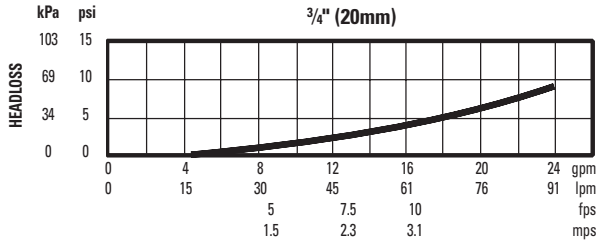
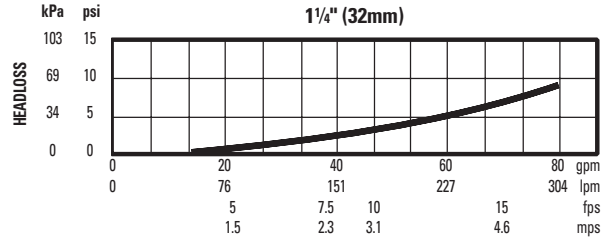
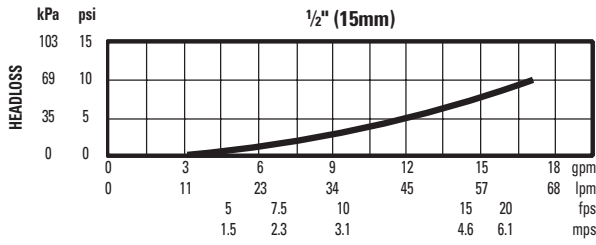

## Materials

Valve Body: Bronze  
 Elastomers: Nitrile  
 Poppet: Acetal/Polypropylene

## Pressure – Temperature

Max. Working Pressure: 150psi (10.3 bar)  
 Hydrostatic Test Press: 150psi (10.3 bar)  
 Temperature Range: 710: 32°F to 110°F (0° - 43°C)  
 715: 32°F to 180°F (0° - 82°C)

## Dimensions and Weights

SIZE (DN)		DIMENSIONS								WEIGHT	
in.	mm	A		B		C		D		lbs.	kgs.
		in.	mm	in.	mm	in.	mm	in.	mm		
1/2	15	2 1/4	64	1/4	32	1 1/4	32	2 1/2	64	.75	.3
3/4	20	2 7/8	73	1 3/8	35	1 3/8	35	2 1/2	64	1	.5
1	25	3 1/2	89	1 3/8	35	1 1/2	38	3 1/4	83	1.75	.8
1 1/4	32	3 3/8	98	1 5/8	41	2	51	4	102	2.5	1.1
1 1/2	40	4 5/8	118	2 1/8	54	2 1/8	54	4 1/2	114	3.75	1.7
2	50	5 7/8	137	2 3/8	54	2 3/8	54	5 1/2	140	5.25	2.4

**Note:** Weights shown are approximate. Dimensions shown are nominal, allowance must be made for normal manufacturing tolerances.

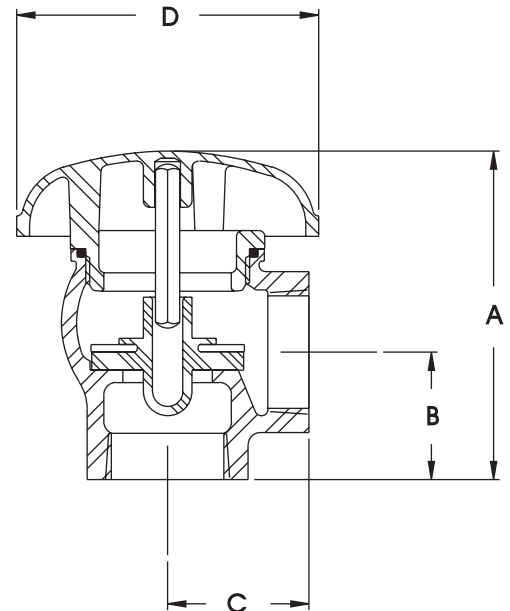

A Division of Watts Water Technologies, Inc.

3816 S. Willow Ave. • Fresno, CA • 93725 • Tel. (559) 441-5300 • Fax: (559) 441-5301

www.FEBCOonline.com